

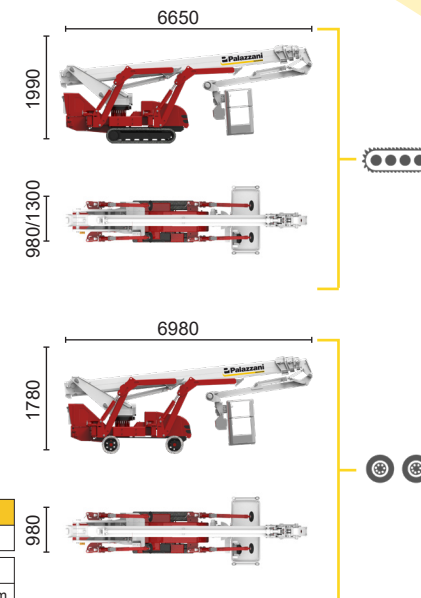

BI-ENERGY

Diesel
14,7 kW

Single-phase
Electric motor
230VAC - 2,2 kW

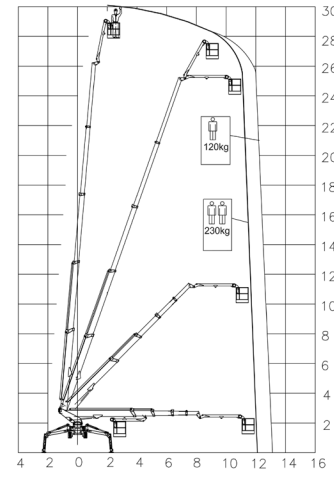
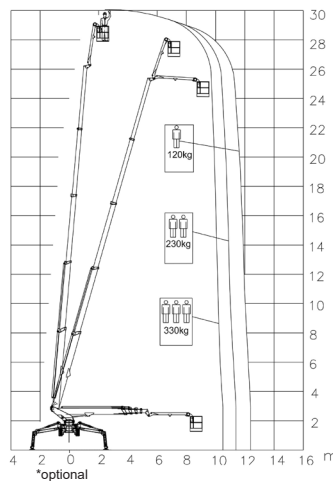

10,5 m	11,4 m	12,4 m	7,5 m	
330 kg*	230 kg	120 kg	120/230 kg	
L1	L2	W1	W2	W3
4927 mm	6436 mm	4791 mm	3828 mm	2865 mm

12 m	13 m	8 m		
230 kg	120 kg	230/120 kg		
L1	L2	W1	W2	W3
4927 mm	6436 mm	4791 mm	3828 mm	2865 mm

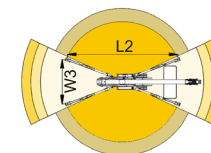
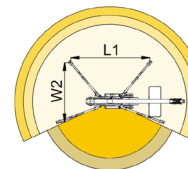
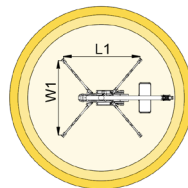
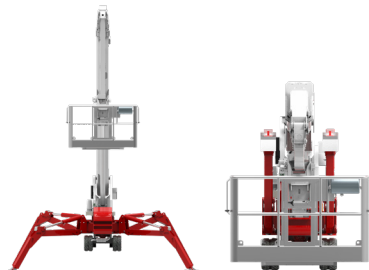

TSJ 30.1/C		30 m	13 m	330 kg*	660°	180x70 cm	90°+80°	2,86-4,79 m	44%	42%	1,2 km/h	4580 kg	29 kN	1,94 kN/m2	3,83 kN/m2
TSJ 30.1/R		30 m	13 m	330 kg*	660°	180x70 cm	90°+80°	2,86-4,79 m	44%	29%	1,2 km/h	4840 kg	29 kN	2,05 kN/m2	3,85 kN/m2

Available power options:

BI-ENERGY (DIESEL+AC)

ECO (AC+BATTERY)

HYBRID* (DIESEL+AC+BATTERY)

Characteristics and technical data are informative only and subjected to change without notice.

Palazzani Industrie S.p.A.

Via del Pavione, 4 - 25050 - Paderno F.C. (BS) - Italy

Tel. (+39) 0306857073

info@palazzani.it

www.palazzani.it



NC 828 A 22